



User's Information Guide

American Standard AccuClean™ Whole House Air Filtration System



Congratulations – Your American Standard AccuClean™ air filtration system is the most advanced, innovative and effective whole house air filtration system on the market today. It is designed to deliver clean air throughout your home. It delivers air that is meticulously filtered and cleaned of up to 99.98% of allergens to provide maximum comfort. You and your family can breathe easier than ever before.

Figure 1. COMPONENTS OF THE ACCUCLEAN™

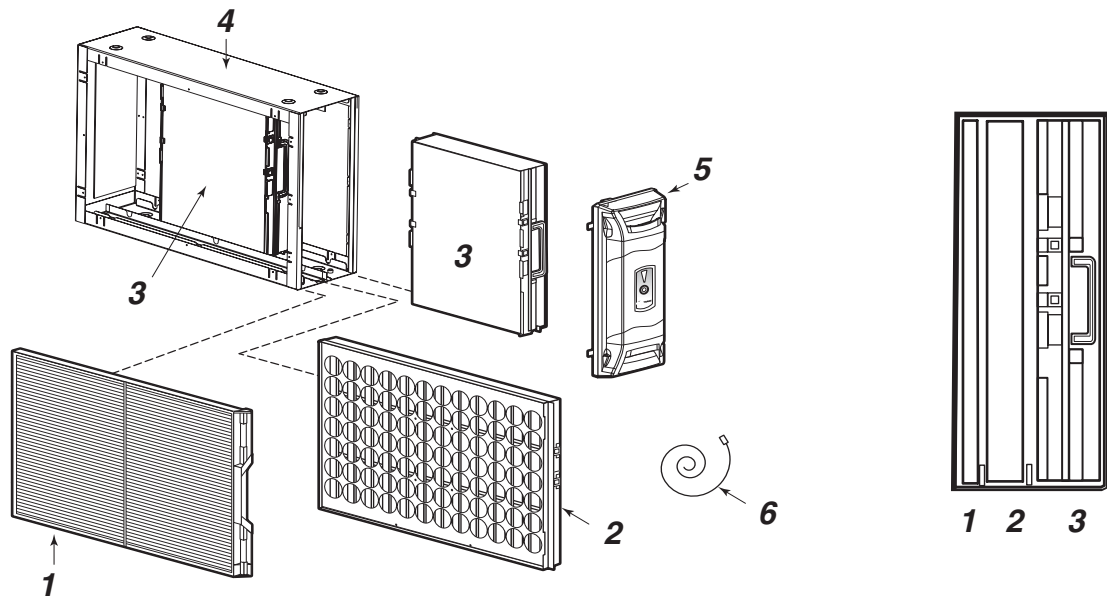

Fig. 1

- 1) **Pre-filter** - Traps large particles such as hair and lint before they can enter the cell section.
- 2) **Field Charger** - Charges the contaminants. Only to be serviced by a qualified technician.
- 3) **Collection Cell (2)** - Removes and collects very small impurities from the air.
- 4) **Cabinet** - Mounts between the furnace or air handler and return air duct work and houses the collection cells, field charger and pre-filter.
- 5) **Power Door** - The solid state power supply components that convert the 24 Volt AC to the high-voltage, direct current required to power the field charger and cells. Allows access to the collection cells, field charger and pre-filter.
- 6) **24 Volt Power Cable**

DISPLAY FEATURES

The air cleaner display (Fig. 2) has the following functions:

LED and Pre-filter lights display the operating status of the air cleaner, indicating when to clean the pre-filter or collection cells.

The LED display is also used in the set-up mode, see page 5.

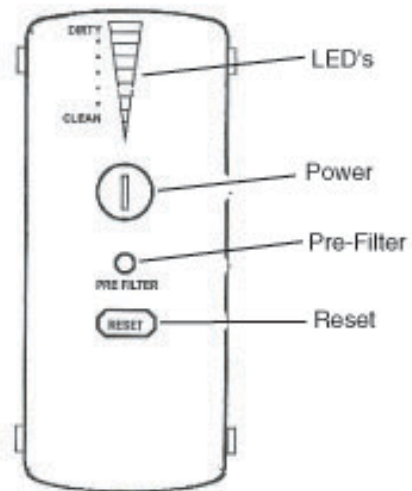

Fig. 2

SEQUENCE OF OPERATION

You will need to turn off your air cleaner to clean the filters. After cleaning, turn on the unit by pressing and releasing the Power button. The backlit Power and Filter Reset button will illuminate along with first green LED indicating power is present. When the indoor fan is operating the first green LED will slowly flash. This indicates the field charger and collection cells have power and the unit is operating normally. There is a slight time delay between the indoor fan starting and LED flashing.

NOTE: There is a 10 minute delay after the indoor fan operates, before the air cleaner starts to operate, each time the power to the air cleaner is turned off/on. This can be bypassed by going into and then out of the Set-Up Mode.

Your air filtration system only operates when the air is circulating through the indoor unit. The air filtration system is most effective at cleaning the air if the fan operates continuously. Most thermostats have a setting that will permit continuous fan operation. Continuous fan mode during Cooling operation may not be appropriate in humid climates. If the indoor air exceeds 60% relative humidity or simply feels uncomfortably humid, it is recommended that the fan only be used in the AUTO mode. In normal operation, the air cleaner may make a slight sound as the air passes through it and is cleaned. In some applications, you may notice this sound coming from the return air vent(s). If desired, this sound level can be reduced with minimal impact on air cleaning efficiency by reducing the power setting of the field charger in the set-up mode (see p.5-6).

MAINTENANCE

In normal use, the pre-filter should be cleaned every 2 months and the collection cells should be cleaned every 6 months. The field charger should be cleaned only by a qualified service technician annually.

⚠ CAUTION

This equipment should be inspected frequently and collected dirt removed from it regularly to prevent excessive accumulation that may result in flashover or risk of fire. The field charger should only be removed and cleaned by authorized service personnel.

CLEANING INDICATORS

Both the pre-filter and the collection cells have timers which monitor actual run time of the unit and indicate when cleaning is required. The time between cleaning can be adjusted based on your preferences and conditions in the home. See the SET-UP MODE section on page 5 to change the filter timers.

The red PRE-FILTER light will illuminate when it is time to clean the pre-filter.

The clean/dirty light bar indicator will illuminate as the system cleans the air in your home. The lights will progress from green to yellow then to red. When the last red indicator is flashing it is time to clean the collection cells.

REMOVING FILTERS FOR CLEANING

◆ Turn the furnace/ air conditioning system off at the thermostat.

⚠ CAUTION

High voltage is present within the air cleaner for operation. Before removing the door, turn the power off and wait at least 15 seconds to allow voltage to discharge.

◆ Turn off power by pushing and holding the power button for approximately three seconds until all the LED's illuminate. Release the power button. The LED's will remain on until the voltage has discharged and it is safe to remove the door.

This requires approximately 15 seconds. Do

not remove the door until all lights are off.

- ◆ Disconnect the power cable, if required, and place the door in a secure location.
- ◆ Rotate the two latches and remove the door.

PRE-FILTER CLEANING:

The pre-filter can be vacuumed (recommended) or washed clean.

It is recommended the filter be vacuumed outside the home to ensure particles on the filter are not re-introduced into the air.

Persons highly sensitive to the collected particles should wear appropriate respiratory protection while cleaning the filter.

The pre-filter can be washed using low pressure water spray, such as a sink sprayer or garden hose. The pre-filter should be completely dry before re-installing. Re-install the pre-filter noting the airflow direction as indicated on the filter.

NOTE: Do not replace the plastic pre-filter with a metal type pre-filter. A metal pre-filter will cause reduction in efficiency and potential failure of the system electronics.

COLLECTION CELL CLEANING

Remove both collection cells from the system housing. The cells can be cleaned either by vacuuming (recommended method) or by washing.

VACUUM CLEANING

Using the wand attachment, vacuum both sides of the collection cells until they are clean

It is recommended the filter be vacuumed outside the home to ensure particles on the filter are not re-introduced into the air. Persons highly sensitive to the collected particles should wear appropriate respiratory protection while cleaning the filter.

WASHING

Use low-pressure water spray, such as a sink sprayer or garden hose to clean the cells. Stubborn residue like tobacco smoke may require warm water to be removed.

Do NOT use soap or detergent in cleaning the collection cells.

Do NOT immerse the cells completely in water.

Do NOT place the cells into a dishwasher to clean.

Slightly tap the collection cells to remove water retained in the filter. Allow the collection cells to dry completely before re-installing.

Re-install the collection cells. With the handles facing the front of the unit, align the slot on the cell with the tab on the cabinet. Fold the collection cell handles flat once installation is complete.

RE-INSTALLING THE POWER DOOR

Install the door by positioning tabs inside of the frame and rotating the door into place. Rotate the two latches to secure the door. Plug in the power cable if removed. Turn on power to the unit by pressing and releasing the power button.

NOTE: The first green LED will be on but will not flash for the first 10 minutes the indoor fan is operating. This is a drying cycle for the pre-filter and collection cells.

RESET THE FILTER TIMERS

To reset the pre-filter timer, press and hold the RESET button until the pre-filter LED turns off. (1 to 2 seconds)

To reset the collection cell timer, press and continue to hold the RESET button until the collection cell LED's turn off. (4 to 5 seconds)

SET-UP MODE

You can customize the performance of the air cleaner to meet the needs of your home and family using the set-up mode.

To enter the set-up mode, press and hold BOTH the Power and the filter RESET buttons for a minimum of 5 seconds. The LED display will light up indicating the current settings as shown in Figure 3 to the right.

You may select the cleaning intervals of the pre-filter and the collection cells as well as the power setting of the field charger by cycling through the various settings (see page 6). Once you have made the desired changes, press and hold BOTH the Power and the filter RESET buttons for a minimum of 5 seconds to exit the set-up mode.

Factory settings

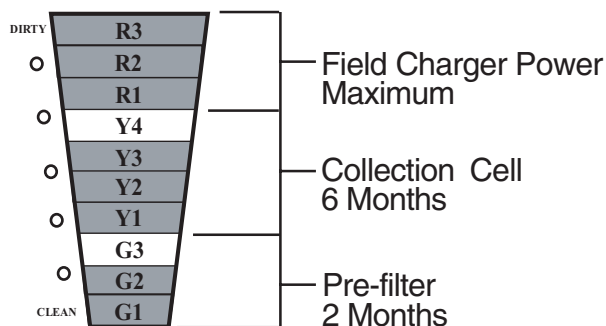

Fig. 3

Pre-Filter Timer Setting

The GREEN LED lights are used to set the pre-filter cleaning interval for one, two, or three months. The number of illuminated GREEN LED lights indicates the current setting. The factory setting is 2 months.

Collection Cell Timer Setting

The YELLOW LED lights are used to set the collection cells cleaning interval for two, four, six, or nine months. The number of illuminated YELLOW LED lights indicates the current setting as shown in Figure 5. The factory setting is 6 months.

Field Charger Power Level Setting

The RED LED lights are used to set the power level of the field charger for maximum, medium, or minimum. The number of illuminated RED LED lights indicates the current setting as shown in Figure 6. The factory setting is for maximum.

Lower settings will reduce the slight sound emitted by the unit with minimal loss of air cleaning efficiency, if desired.

Lower settings will also further reduce the very low ozone produced by the air cleaner. The U.S. Food and Drug Administration recommends indoor ozone concentrations should not exceed 50 parts per billion. Your air cleaner will contribute only 5 parts per billion at the factory setting and can be reduced to 3 parts per billion at the minimum setting.

CHANGING THE SETTINGS

While in the set-up mode, press the Power button once to begin cycling through the various setting options in the following order:

Pre-Filter Cleaning Interval Setting (Figure 4)

One or more of the GREEN LED lights will illuminate. To change the reminder interval time, press the Reset button until the desired setting is indicated, and then press the Power button again.

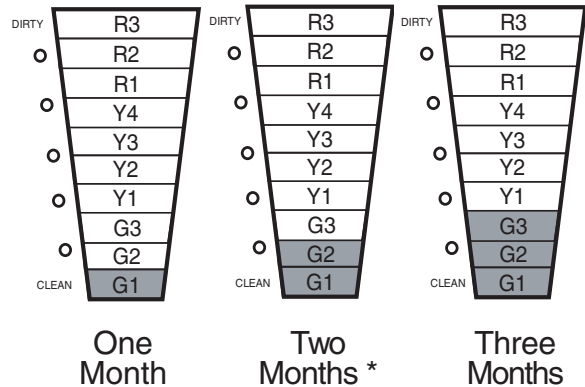

Fig. 4

Collection Cells Cleaning Interval Setting (Figure 5)

One or more of the YELLOW LED lights will illuminate. To change the reminder interval time, press the Reset button until the desired setting is indicated, and then press the Power button again.

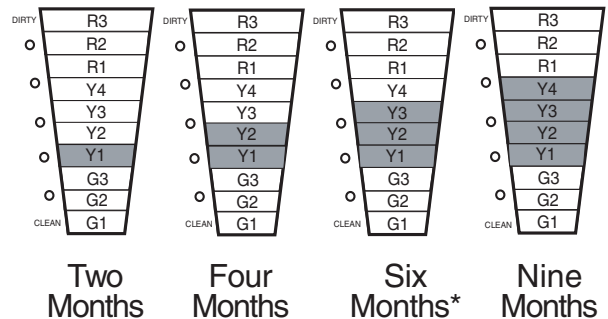

Fig. 5

Field Charger Power Level Setting (Figure 6)

One or more of the RED LED lights will illuminate. To change the power level setting, press the Reset button until the desired setting is indicated.

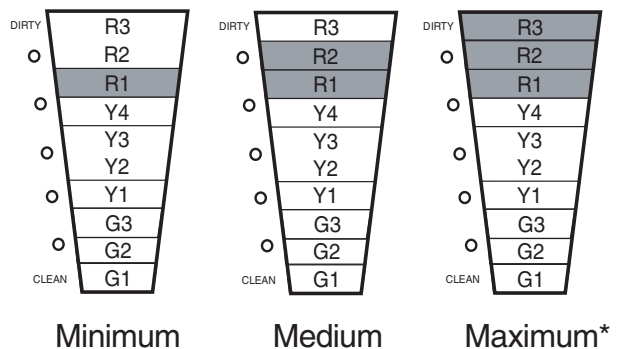

Fig. 6

* Factory settings

To save your new settings and exit the set-up mode, press and hold BOTH the Power and filter RESET buttons for a minimum of 5 seconds.

FAULT INDICATORS

The air cleaner has been designed to continually monitor itself to insure it is working properly. If it detects a problem, all four YELLOW LED lights will flash continuously.

If this occurs, turn the unit off and clean both the pre-filter and the collection cells to insure no large material is trapped in the filters and causing the fault.

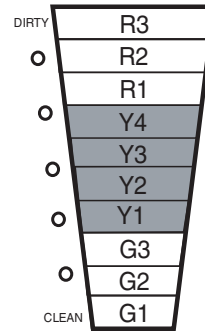

If the unit detects any other type of fault, all three RED LED lights will flash continuously. The filter will shut down and does not represent a safety risk. You should call a qualified service technician for service.

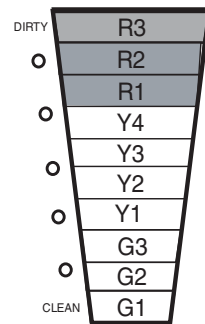



Limited Warranty
AccuClean™ Air
Cleaner
AFD
(Parts Only)

This limited warranty is extended by American Standard Inc., to the original purchaser and to any succeeding owner of the real property to which the AccuClean™ Air Cleaner is originally affixed, and applies to products purchased and retained for use within the U.S.A. and Canada.

If any part of your AccuClean™ Air Cleaner fails because of a manufacturing defect within five years from the date of the original purchase, Warrantor will furnish without charge the required replacement part. In addition, if the electronics fail because of a manufacturing defect within the sixth through tenth year from the date of the original purchase, Warrantor will furnish without charge the required replacement part. Any local transportation, related service labor, mechanical filters and diagnosis calls are not included.

This limited warranty does not cover failure of your AccuClean™ Air Cleaner if it is damaged while in your possession, damage caused by unreasonable use of the AccuClean™ Air Cleaner and/or damage from **failure to properly maintain** the AccuClean™ Air Cleaner as set forth in the Use and Care manual (**see Proper Maintenance section**).

THE LIMITED WARRANTY AND LIABILITY SET FORTH HEREIN ARE IN LIEU OF ALL OTHER WARRANTIES AND LIABILITIES, WHETHER IN CONTRACT OR IN NEGLIGENCE, EXPRESS OR IMPLIED, IN LAW OR IN FACT, INCLUDING IMPLIED WARRANTIES OF MERCHANTABILITY AND FITNESS FOR PARTICULAR USE, AND IN NO EVENT SHALL WARRANTOR BE LIABLE FOR ANY INCIDENTAL OR CONSEQUENTIAL DAMAGES.

Some states do not allow limitations on how long an implied limited warranty lasts or do not allow the exclusion or limitation of incidental or consequential damages, so the above limitation or exclusion may not apply to you. This limited warranty gives you specific legal rights, and you may also have other rights which vary from state to state.

Parts will be provided by our factory organization through an authorized service organization in your area listed in the yellow pages. If you wish further help or information concerning this limited warranty, contact:

American Standard Inc.
Troup Highway
Tyler, TX 75711-9010
Attention: Manager, Field Operations Excellence

AW-178-4005

P.I.